

WNP84SECUK

EAN Code	8017709327538
Product Family	Washing Machine
Commercial width	60 cm
Commercial depth	Standard capacity
Installation	Free-standing
Load type	Frontal

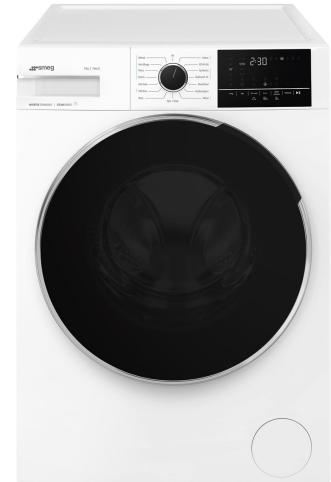

Programs / Functions

Controls

Programmes graphics

No. of programmes

Programmes

Electronic

Written in EN

15

Eco 40-60

Duvet

Outdoor

Wool/Hand wash

Self Clean

 Cotton

 Stain-resistant

 Mix Rinse

 Drain + Spin

 Mix

 Shirts

 Anti-allergy

 Quick Wash 14 min

 Synthetics

Refresh

Washing Temperature

Cool

20°C

30°C

40°C

60°C

90°C

Special programmes

Outdoor

Refresh

 Anti-allergy

Stain resistant

 Wool

Display

Residual time indicator delay start

Display type



Buttons/Options



Delay timer

Spin Speed

Temperature



Prewash



Quick



Steam

Programme progress indicator (light)

Lights

End of cycle indicator (light)

On display

Technical Features



Type of motor	Brushless/Inverter
Electronic control functioning	Yes
Programme selection knob	Yes
Spin speed selection on display/LED	No spin/ 600/ 800/ 1200/ 1400/ Rinse hold
Display/led for temperature regulation	Yes
Polypropilene tank	Yes
Basket	Stainless steel
Drum capacity	55 l

Liquid detergent accessory as standard	Yes
Door diameter	34 cm
Door opening	160°
Automatic variable load	Yes
Antifoam system	Yes
Load balancing system	Automatic
Easy to access filter	Yes
Child lock (functions block)	Control block

Performance / Energy Label NEW



Supplier's name or trademark	SMEG	Spin-drying efficiency class	B
Rated Capacity	8 kg	Airbone acoustical noise class	A
Energy Efficiency Class	C	Airbone acoustical noise	72 dB(A) re 1 pW
Energy_cons_100	62 kWh	Programme duration at rated capacity	3:38 h:min
Water Consumption	46 litres		

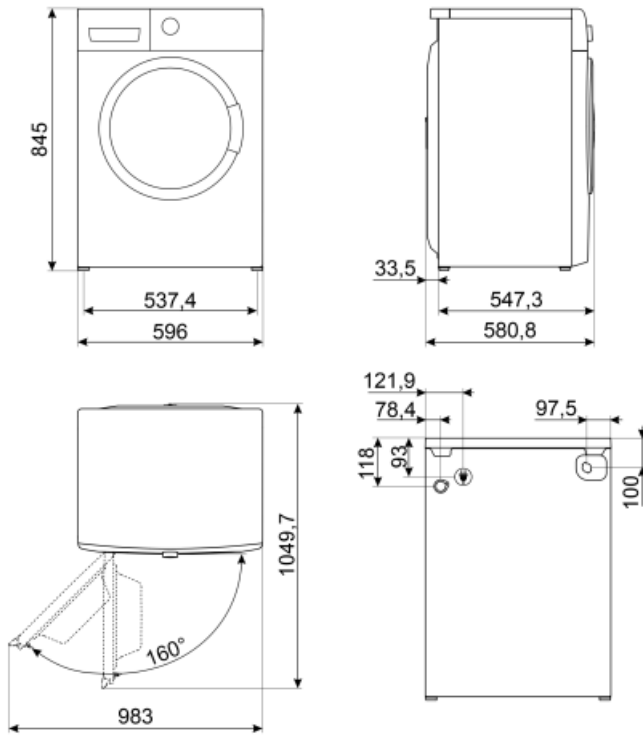





















Not included accessories

KITPLV2

Kit extension for dishwasher and washing machine: length mt. 2



Symbols glossary

 <p>Variable load: In all models of washing machines is present the system of variable load, according to which the machine automatically diversifies the wash cycle and the time of operation depending on the quantity and type of laundry introduced, allowing a significant saving of water and energy power, up to 30% compared to the versions with fixed load.</p>	 <p>Automatic Load Balancing: provides an ideal distribution of laundry in the drum. In case if the imbalance is detected, the rotation speed starts being controlled in such way to evenly redistribute laundry in the drum, and thus reduce vibration.</p>
 <p>Child lock: some models are fitted with a device to lock the programme/cycle so it cannot be accidentally changed.</p>	 <p>Delay timer: can be set to run the programme at a convenient time or to take advantage of off-peak energy periods.</p>
 <p>LED display: to show programmes, functions and options selected and the time to the end of the cycle.</p>	 <p>34 cm: Large loading hatch of 34 cm in diameter, makes laundry loading and unloading easier and faster with maximum ease of use.</p>
 <p>This option advises when the periodic cleaning of the filters is needed, in order to avoid forgetfulness and thus guarantee the perfect functioning of the dryer over time. The convenient position of the filters makes maintenance fast and extremely simple.</p>	 <p>Inverter technology: The evolution of Smeg's driers towards more intelligent and environmentally sustainable models has led to the choice of using Inverter technology with heat pumps, which reduces significantly energy consumption.</p>
 <p>Prewash: program designed for heavily soiled garments.</p>	 <p>Antiallergic: Antiallergic program with particular attention to the total removal of residual detergent.</p>
 <p>Cotton: For soiled fabrics in cotton</p>	 <p>To drain the water in the machine.</p>
 <p>Mixed fabrics: this cycle is designed for lightly soiled laundry in a mix of cottons and synthetics, or can be used just to refresh stored items.</p>	 <p>Super fast 14 min.: a programme designed to wash small amounts of laundry fast, ideal for washing lightly soiled garments.</p>
 <p>Refresh: an ideal program to refresh the garments that have been kept for a long time indoors and eliminate unpleasant odors, without having to wash.</p>	 <p>Extra rinse: The Extra rinse option: can be added to the selected programme when more thorough cleansing of special fabrics is needed.</p>
 <p>Shirts: a cycle to wash shirts in a short time with the utmost care, using a delicate spin for easy ironing.</p>	 <p>Synthetics: to wash your synthetic clothes (shirts, blouses, synthetic/cotton blends, etc.). It washes with a gentle action and has a shorter washing cycle compared to the Cottons programme. For curtains and tulle, use the Synthetic 40°C programme with prewash and anti-creasing functions selected. As their meshed texture causes excessive foaming, wash the veils/tulle by putting little amount of detergent into the main wash compartment. Do not put detergent in the prewash compartment.</p>
 <p>Wool: this programme for wool or delicate fabrics uses slower rotations of the drum to ensure the utmost care for clothing.</p>	 <p>Option that allow to reduce times of the selected program.</p>



Steam Option: the steam is perfect for smoothing out creases, refreshing fabrics, neutralizing odors and releasing dirt, destroying allergens more quickly than by washing the item in water.



Drum has maximum capacity of 8kg of dry laundry.



Energy efficiency class C